

# Instructions for use

---

**SAFE® CAP 4CHANNEL HH**

**Semi-Automated 4-Channel Capper/Decapper for SBS 24**



## Contents

<b>1</b>	<b>Information about the documentation.....</b>	<b>3</b>
1.1	Conventions.....	3
1.1.1	Warning signs .....	3
1.1.2	Symbols .....	3
1.1.3	Typographical emphasis .....	3
1.2	Instructions for use.....	3
1.3	Product information .....	3
<b>2</b>	<b>Safety .....</b>	<b>4</b>
2.1	Warnings.....	4
2.2	Safety information.....	4
2.2.1	General safety information for electrical tools .....	4
2.2.2	Additional safety information .....	6
<b>3</b>	<b>Description .....</b>	<b>8</b>
3.1	Product overview .....	8
3.2	Designated usage .....	9
3.3	Charger .....	9
3.3.1	Connect charger .....	9
3.3.2	Charge status display.....	10
3.4	Charge status rechargeable battery .....	10
3.5	Scope of delivery .....	11
<b>4</b>	<b>Technical details.....</b>	<b>12</b>
4.1	Decapper .....	12
4.2	Charger .....	12
4.3	Rechargeable battery .....	12
4.4	Noise information and vibration values determined in accordance with EN 60745 .....	13
<b>5</b>	<b>Operation .....</b>	<b>13</b>
5.1	Screw process.....	13
5.1.1	Unscrew caps.....	13
5.1.2	Screw caps tight.....	14
<b>6</b>	<b>Care, maintenance, transport and storage .....</b>	<b>15</b>
6.1	Care of the device.....	15
6.2	Maintenance of the Li-Po rechargeable batteries.....	15
6.3	Transport and storage .....	15
<b>7</b>	<b>Assistance in the event of faults.....</b>	<b>16</b>
<b>8</b>	<b>Disposal .....</b>	<b>16</b>
<b>9</b>	<b>Manufacturer warranty .....</b>	<b>16</b>

## 1 Information about the documentation

### 1.1 Conventions





#### 1.1.1 Warning signs

The following warning signs are used:

	Warning of general hazard
---	---------------------------

#### 1.1.2 Symbols

The following symbols are used:

	Please read instructions for use before use
	Instructions for use and other useful information
	Direct current
	Revolutions per minute

#### 1.1.3 Typographical emphasis

The following typographical features emphasise important passages of text in the technical documentation of your decapper:

	The numbers refer in each case to illustrations
---	---

### 1.2 Instructions for use

- ▶ Please be sure to read through the instructions for use before you put the device into operation.
- ▶ Always store these instructions for use with the device.
- ▶ Only pass the device with its instructions for use to other people. Subject to change without notice. Errors excepted.

### 1.3 Product information

The type of designation and serial number are found on the side of the housing.

- ▶ Please provide these details when you contact our representative or service point.

Product details

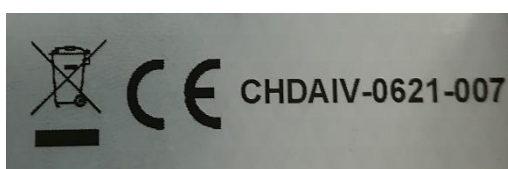



**CHDAIV – 0621 – 007**  
 CHD = Cryo.s Hand-held Decapper  
 AVI = 4 Channel external thread  
 1115 = mmyy (month/year)  
 XXX = sequential serial number

## 2 Safety

### 2.1 Warnings

Function of the warnings

Warnings of dangers when handling the product. Description of the signal words used:

	<p><b>HAZARD</b></p> <p>For the immediate threat of a danger that results in serious physical injury or death.</p>
	<p><b>WARNING</b></p> <p>For a potentially dangerous situation that can result in serious physical injury or death.</p>
	<p><b>CAUTION</b></p> <p>For a potentially dangerous situation that can result in minor physical injury or damage to property.</p>

### 2.2 Safety information

The safety information in the following chapter includes all the general safety information for electrical tools that are to be listed in the instructions for use pursuant to the applicable standards. Accordingly, there may be information in it that is not relevant for this device.

#### 2.2.1 General safety information for electrical tools

	<p><b>WARNING</b></p> <p>Read all safety information and instructions. Failures to comply with the safety information and instructions can result in an electric shock, fire and/or serious injury.</p>
---	---

Retain all safety information and instructions for the future.

The term “electrical tool” used in the safety information refers to mains-powered electrical tools (with a mains cable) and to electrical tools operated by a (rechargeable) battery (without mains cable).

Safety at the workplace

- ▶ Keep the area where you work clean and well-lit. Untidiness or unlit work areas can result in accidents.
- ▶ Do not work with the electrical tool in explosive environments in which there are flammable liquids, gases or dusts. Electrical tools produce sparks that can ignite dust or vapours.

► Keep children and other persons away when you are using the electrical tool. If you are distracted, you may lose control over the device.

### **Electrical safety**

► The AC connector plug of the charger has to fit in the socket. The plug may not be modified in any way. Only use plugs or adapters that are supplied with the device. Unmodified plugs and the right sockets reduce the risk of an electric shock.

► Avoid physical contact with earthed surfaces such as pipes, radiators, stoves and refrigerators. There is an increased risk from an electric shock if your body is earthed.

► Keep electrical tools away from rain or moisture. If water penetrates into an electrical tool, this increases the risk of an electric shock.

► Do not misuse the cable to carry the electrical tool, to hang it up, or to pull the plug out of the socket. Keep the cable away from heat, oil, sharp edges or moving device parts. Damaged or tangled cables increase the risk of an electric shock.

► The electrical tool is designed solely for use in closed rooms and a dry environment. Other use is prohibited.

► The electrical tool should not be used in the direct vicinity of highly sensitive electronic devices.

### **Safety of people**

► Pay attention, watch what you do and be sensible when working with an electrical tool. Do not use any electrical tool if you are tired or are under the influence of drugs, alcohol or medication. A moment of inattentiveness when using the electrical tool can lead to serious injuries.

► Wear personal protective equipment and always wear protective goggles. Wearing personal protective equipment, such as a dust mask, non-slip safety shoes, protective helmet or hearing protectors, depending on the type and use of the electrical tool, reduces the risk of injuries.

► If you have your finger on the switch when carrying the electrical tool or connect the device to the power supply when it is switched on, this can result in the device starting unintentionally.

► Remove adjustment tools or spanners before you switch on the electrical tool. A tool or key that is in a turning part of the device can lead to injuries.

► Ensure you have a secure footing and keep your balance at all times. You can thus control the electrical tool better in unexpected situations.

► Wear appropriate clothing. Do not wear any loose clothing or jewellery. Keep hair, clothing and gloves away from moving parts. Loose clothing, jewellery or long hair can become trapped in moving parts.

### **Use and handling of the electrical tool**

- ▶ Only use the electrical tool intended for this purpose for your work.
- ▶ Store the electrical tool in the stand that is supplied with it.
- ▶ Do not use any electrical tool that has a defective switch. An electrical tool that can no longer be switched on or off is dangerous and must be repaired.
- ▶ Keep unused electrical tools out of the reach of children. Do not allow persons who are not familiar with the device or have not read these instructions of use to use the device. Electrical tools are dangerous when they are used by inexperienced people.
- ▶ Look after electrical tools with care. Check whether movable parts work perfectly and do not jam, whether parts are broken or are so damaged that the functioning of the electrical tool is impaired. Have damaged parts repaired before you use the device. Many accidents are caused by poorly maintained electrical tools.
- ▶ Use electrical tools, accessories, insertion tools, etc. in accordance with these instructions. Take the work conditions and the task to be carried out into account. The use of electrical tools for applications other than those envisaged can result in dangerous situations.

### **Use and handling of the rechargeable battery tool**

- ▶ Only charge the rechargeable batteries with the charger supplied with the device and which is recommended by the manufacturer. A charger that is suitable for a certain type of rechargeable battery harbours the risk of fire if it is used with other rechargeable batteries.
- ▶ Only use the rechargeable batteries envisaged for this purpose in the electrical tools. Using other rechargeable batteries can result in injuries and the risk of fire.
- ▶ Keep the rechargeable battery away from paper clips, coins, keys, nails, screws or other small metal items that could cause a bridging of the contacts. A short circuit between the rechargeable battery contacts can result in burns or fire.
- ▶ If it is used incorrectly, liquid can leak out of the rechargeable battery. Avoid any contact with it. If you accidentally come into contact with it, rinse off with water. If you get the liquid in your eyes, please also seek medical assistance. Leaking rechargeable battery liquid can result in skin irritations or burns.

### **Care of your device**

- ▶ Only have your electrical tool repaired by qualified specialist staff and only with original spare parts. It is thus ensured that the safety of the device is preserved.

#### 2.2.2 Additional safety information

### **Safety of people**

- ▶ It is not permitted to tamper with or make changes to the device.

Take breaks in your work and do relaxation and finger exercises to improve the circulation in your fingers.

- ▶ Avoid contact with rotating parts. Only switch the device on in the work area. Contact with rotating parts, in particular rotating insertion tools, can result in injuries.
- ▶ The device is not intended for people who have not been given instruction.

### **Careful handling and use of electrical tools**

- ▶ Ensure that the screw caps and the workpiece are suitable for the torque that is generated by the device. Too high a torque can put excessive strain on the screw connection or the workpiece, or stretch or damage it, and thus result in dangerous situations.

### **Careful handling and use of rechargeable battery devices**

- ▶ The device is supplied ex works with a fitted rechargeable battery. All work on and around the rechargeable battery is to be carried out solely by the manufacturer.
- ▶ Keep rechargeable batteries away from high temperatures and fire. There is a risk of explosion.
- ▶ The rechargeable batteries may not be taken apart, crushed, heated up or burned. Otherwise, there is a risk of fire, explosion and injury.
- ▶ Do not let moisture penetrate into the device. Water that has penetrated into the device can cause a short circuit and result in burns or fire.
- ▶ Comply with the operating temperature.
- ▶ For shipping, discharge the rechargeable battery to 30% for safety reasons.
- ▶ Lengthy storage and the wrong temperature can result in the battery discharging and being destroyed. If it is not used, the rechargeable battery is to be recharged to approx. 55–75% every six months.
- ▶ Avoid a short circuit on the rechargeable battery. Before inserting the rechargeable battery into the device, check that the contacts of the rechargeable battery and in the device are free of foreign matter. If contacts of a rechargeable battery are short-circuited, there is a risk of fire, explosion and chemical burns.
- ▶ Damaged rechargeable batteries (e.g. rechargeable batteries with cracks, broken parts or warped contacts and/or contacts that have been pushed back or pulled out) may not be charged or used further.
- ▶ If the rechargeable battery is too hot to touch, it may be defective. Place the device at a non-flammable location with sufficient distance from combustible materials where it can be monitored and let it cool down. Contact the Service team after the rechargeable battery has cooled down.
- ▶ Please ensure that it is disposed of correctly.

### 3 Description

#### 3.1 Product overview

1. Decapper
2. Stand
3. Button white
4. Button blue
5. Cap remover
6. Charger
7. Mains plug EU, UK, US, AUS
8. Charging socket
9. Bit

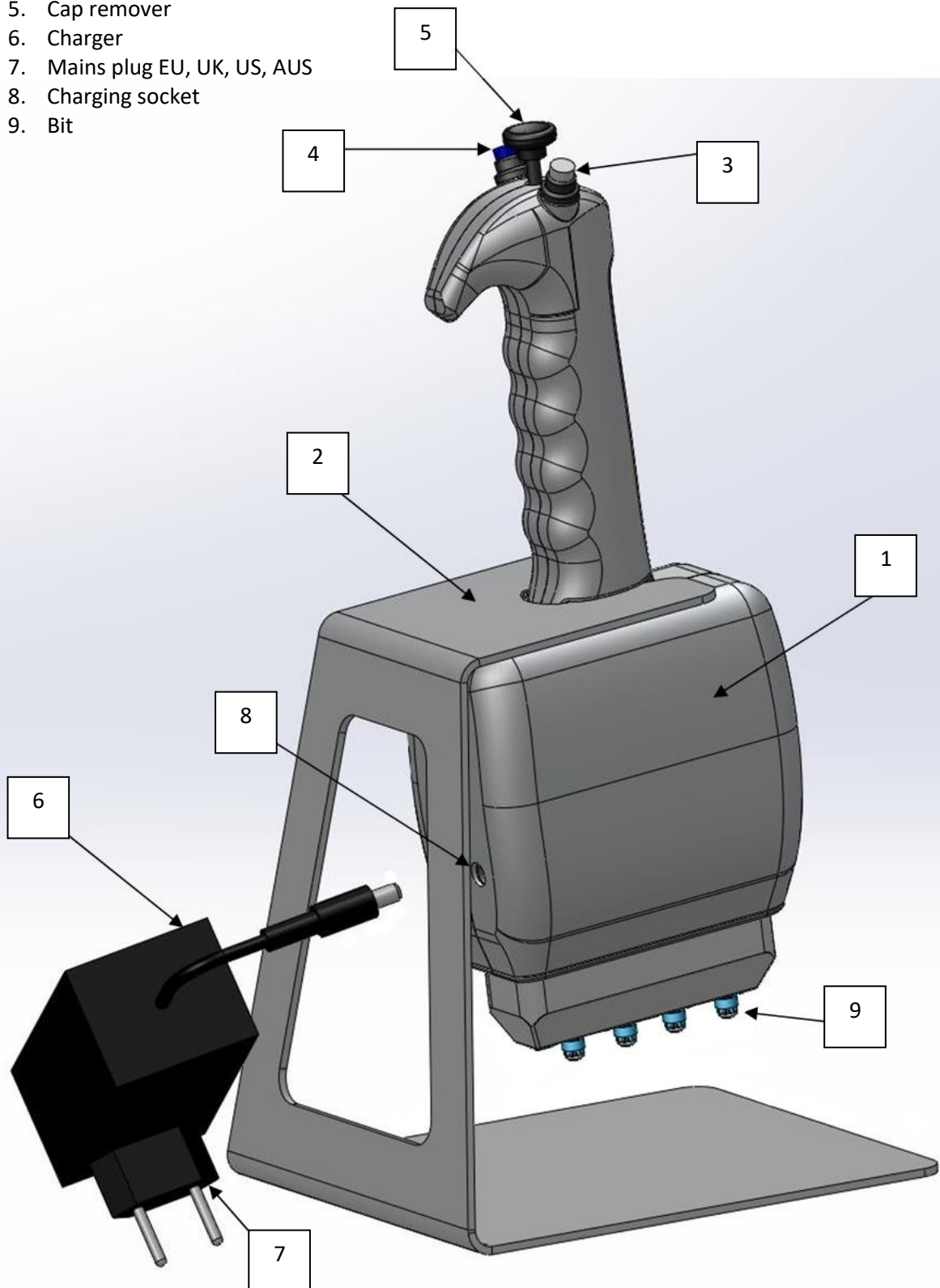



### 3.2 Designated usage

The product described is a hand-operated decapper powered by a rechargeable battery for the unscrewing and screwing of vials which stand in a rack in rows of 4.

The product is intended for the laboratory area under defined ambient temperatures and may only be operated and maintained by authorised and trained staff. This staff must have been specifically instructed in the risks that occur. Risks may result if they are improperly handled by untrained staff or are not used for their designated purpose.



- ▶ Do not use the rechargeable batteries as a source of energy for other non-specified consumption points.
- ▶ Please note the national occupational safety requirements.
- ▶ To avoid risks of injury, only use original accessories and tools.
- ▶ Only use the rechargeable battery that is supplied with the device and the charger tailored specifically to the rechargeable battery to operate the device.

	<p><b>NOTE</b></p> <p>Ensure that the charging socket and the DC plug of the charger is clean and dry before you connect the charger. Please read the instructions for use of the charger for the charging process.</p>
---	---

### 3.3 Charger



#### 3.3.1 Connect charger

	<p><b>WARNING</b></p> <p>Electrical risk due to a short circuit</p> <ul style="list-style-type: none"> <li>▶ Ensure that the contacts of the plug and the contacts on the decapper are free of foreign matter before you use the rechargeable battery.</li> </ul>
	<p>Fully charge the rechargeable battery for the first time it is used until the LED lights up green on the charger.</p>

	<p><b>WARNING</b></p> <p>Risk of injury if the decapper is dropped.</p> <p>►If a decapper is dropped, it may endanger you and others. In addition to mechanical damage, there may be damage to the rechargeable battery.</p>
---	--



### 3.3.2 Charge status display

The charge status of the charger is indicated via an LED on the charger.

LED	Info
off	Charger not connected
Orange	Charging current
Orange	Charging voltage
Green	Charging complete

### 3.4 Charge status of the rechargeable battery

The charge status of the rechargeable battery is indicated by the decapper via a sequence of sounds.

Sequence of sounds	Info	Comment	Action
	Recharge rechargeable battery	<p>Rechargeable battery is approaching critical charge status.</p> <p>There is still sufficient capacity in the rechargeable battery to execute the next work step.</p>	Connect rechargeable battery to charger
	Rechargeable battery is empty	<p>Rechargeable battery has reached critical charge status.</p> <p>Insufficient energy available to execute the next work step.</p>	Connect rechargeable battery to charger

### 3.5 Scope of delivery

- Decapper
- Stand
- Instructions for use of decapper
- Charger with accessories
- Instructions for use of charger



 A small icon of a lit lightbulb inside a square frame, indicating a note or important information.	<p><b>NOTE</b></p> <p>For safe operation, only use original spare parts and consumables.</p>
--	--

## 4 Technical details

### 4.1 Decapper

	<b>CHD</b>
Rated voltage	7.4 V DC
Weight	0.6 kg
Rotational speed	100 - 300 rpm
Preset torque	27 Ncm
Screw cap holder	T40 with steel balls

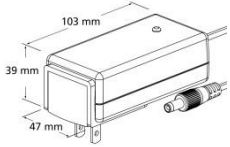
### 4.2 Charger

	<b>Mascot Type 2241</b>
Output voltage	8.4 V DC / 1.3A
DC plug contact	Ø5.5 x 2.1 x 12 mm
Input voltage	90-264 VAC / 47 – 63Hz
Adapter set	<ul style="list-style-type: none"> <li>• Euro</li> <li>• UK</li> <li>• US</li> <li>• AUS</li> </ul> 
Standards	<ul style="list-style-type: none"> <li>• EN 60950</li> <li>• EN 60601-1 3ed</li> <li>• EN 60335-2-29</li> <li>• EN 60601-1-2</li> <li>• EN 61000-6-3</li> <li>• EN 61000-6-1</li> </ul> 
Weight	0.14 kg

### 4.3 Rechargeable battery

	<b>Li-Po 2S1P/IP404860</b>
Rated voltage	7.4 V DC
Protected circuit	integrated

Capacity	1600mAh
Weight	60 g
Storage temperature	20°C +/- 10
Operating temperature	20°C +/- 10

#### 4.4 Noise information and vibration values determined in accordance with EN 60745

The noise and vibration values are below the threshold values stipulated by law.

## 5 Operation

Firstly, fully charge the rechargeable battery before putting it into use for the first time.

When using the appliance, attention should be paid to ensuring that the decapper is placed vertically onto the rows. There should be no notable pressure on the caps.

### 5.1 Screw process

#### 5.1.1 Unscrew caps

- Insert decapper vertically onto the row of closed caps.
- Press handle downwards slightly. If too much pressure is applied, the bits may be compressed.
- Press white buttons.
- The automatic screw process commences: Brief turn in the opposite direction with subsequent unscrewing (maximum torque)

Two options from here:

- After approx. 1 sec, a brief signal is emitted when all four screw caps are released. The spindle still has approx. 2 secs of afterrun.
- In the spindle afterrun, guide the decapper manually upwards vertically.
- The caps are hanging on the bits, separated from the vials.
  
- After approx. 1 sec, four brief signals are emitted if one or more screw caps could not be opened.
- Guide the decapper manually upwards vertically.
- One or more caps are hanging on the bits with the vial
- Manual intervention required

#### 5.1.2 Screw caps tight

- Place decapper with screw caps on the bits vertically onto the row of vials.
  - Press handle downwards slightly. If too much pressure is applied, the bits may be compressed.
  - Press blue button
  - The automatic process commences: Brief turn in the opposite direction with subsequent screwing tight of all bits, until the sealing of the screw tops fits tightly. Sequential subsequent turning to defined tightening torque.
- 
- ✓ As soon as all four screw tops have been correctly closed, a brief signal will sound out.
  - ✓ Activate remover
  - ✓ Guide decapper manually upwards vertically

If the process to screw the tops tightly has not been correctly executed, e.g. oblique fitting of the decapper, not all caps are correctly closed.

⇒ Repeat from Chapter 5.1.1

## 6 Care, maintenance, transport and storage

### 6.1 Care of the device

	<p><b>WARNING</b></p> <p><b>Risks from electric current</b> Improper repairs to electric parts can result in serious injuries.</p> <ul style="list-style-type: none"> <li>▶ Only have repairs to electric parts carried out by a qualified electrician.</li> </ul>
---	--

▶ Keep the device, in particular the gripping surfaces, dry, clean, and clear of oil and fat. Do not use any care products that contain silicone.

▶ Clean the outside of the device on a regular basis with a slightly moistened cloth.

### 6.2 Care of the Li-Po rechargeable batteries

▶ In order to achieve the maximum lifetime of rechargeable batteries, end the discharging as soon as the device's performance declines substantially.

▶ Charge the rechargeable batteries with the approved chargers for Li-Po rechargeable batteries.

### 6.3 Transport and storage

	<p><b>WARNING</b></p> <p><b>Risk of fire</b> Risk of short circuit.</p> <ul style="list-style-type: none"> <li>▶ To prevent short circuits and the associated heating up, Li-Po rechargeable batteries must never be stored or transported in bulk without protection.</li> </ul>
---	---

▶ Please ensure that there are no major knocks during transport.

▶ Please note the permissible storage temperature for the rechargeable battery.

▶ The transport is to be carried out solely in the original packaging. If the packaging is damaged, the device must be checked by a specialist for impeccable functioning and safety.

▶ Please note the nationally and internationally valid transport regulations when shipping rechargeable batteries by road, rail, sea, or air.



	<p><b>NOTE</b></p> <p>The rechargeable battery is ideally stored in a fully charged state in a cool and dry location where possible. The storage of the rechargeable batteries in high ambient temperatures (behind windscreens) is unfavourable, impairs the lifetime of the rechargeable batteries and increases the self-discharging rate of the cells. If the rechargeable battery can no longer be fully charged, it has lost capacity due to age or excessive use. It is still possible to work with this rechargeable battery. However, you should soon replace the rechargeable battery with a new one.</p>
---	---

## 7 Assistance in the event of faults

Please contact our Service team in the event of faults that are not listed in this table or that you cannot rectify yourself.

Fault	Possible cause	Solution
Device does not work	Rechargeable battery is empty	Connect charger until LED on the charger lights up green
Significant heat development in the device or rechargeable battery	Electrical defect	Place the device in a fire-protected area. Inform Service team

## 8 Disposal

	<p><b>CAUTION</b></p> <p><b>Risk of injury</b> Danger due to improper disposal</p> <ul style="list-style-type: none"> <li>▶ The following events can occur in the event of improper disposal of the equipment: Burning plastic parts produce toxic waste gases that people can fall ill from. Batteries can explode and cause poisoning, burns, chemical burns, or environmental pollution if they are damaged or heated up significantly. If you dispose of the equipment without thought, you make it possible for unauthorised persons to make improper use of the equipment. You could seriously injure yourself or third parties and pollute the environment.</li> <li>▶ Dispose of the device immediately. Keep it out of children's reach.</li> </ul>
	<ul style="list-style-type: none"> <li>▶ Dispose of the battery-powered device in accordance with the national regulations or return it to us.</li> <li>▶ Do not take rechargeable batteries apart and do not burn them.</li> </ul>

Pursuant to the European Directive on Waste Electrical and Electronic Equipment and its transposition into national law, used electric devices must be collected separately and recycled in an environmentally friendly manner.

▶ Do not throw electrical tools into household waste!

## 9 Manufacturer warranty

▶ 1 years on mechanical and electrical components (wear parts excluded)

▶ 6 months on rechargeable battery if handled and cared for correctly